



© Pavex Parquet SRL. All rights reserved.
The content of this material is the property
of Pavex Parquet SRL. No part of this material
should be reproduced and / or published
without owner's consent.



8 RAYS DOUBLE FRAME

– ASSEMBLY & DELIVERY MODE –

2011

1. Assembly

once the components ready, these are arranged under the medallion form on the assembly table

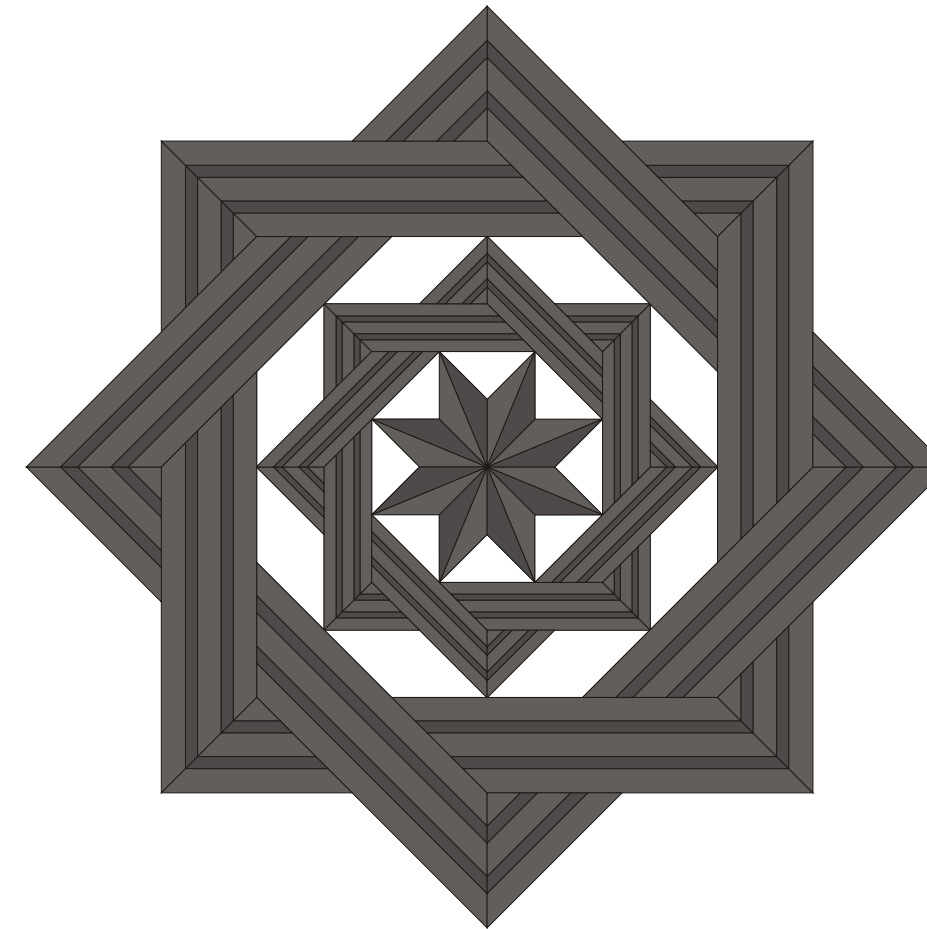

2. The Marks

pieces of cross-filament transparent adhesive tape are glued to the medallion's face with the purpose:

- of temporarily keeping the arranged medallion components in their positions on the assembly table until phase 3 is completed
- to allow the medallion reconstruction at the place of installation in the same form as on the manufacturer's assembly table

Each marker has its own number written on it.

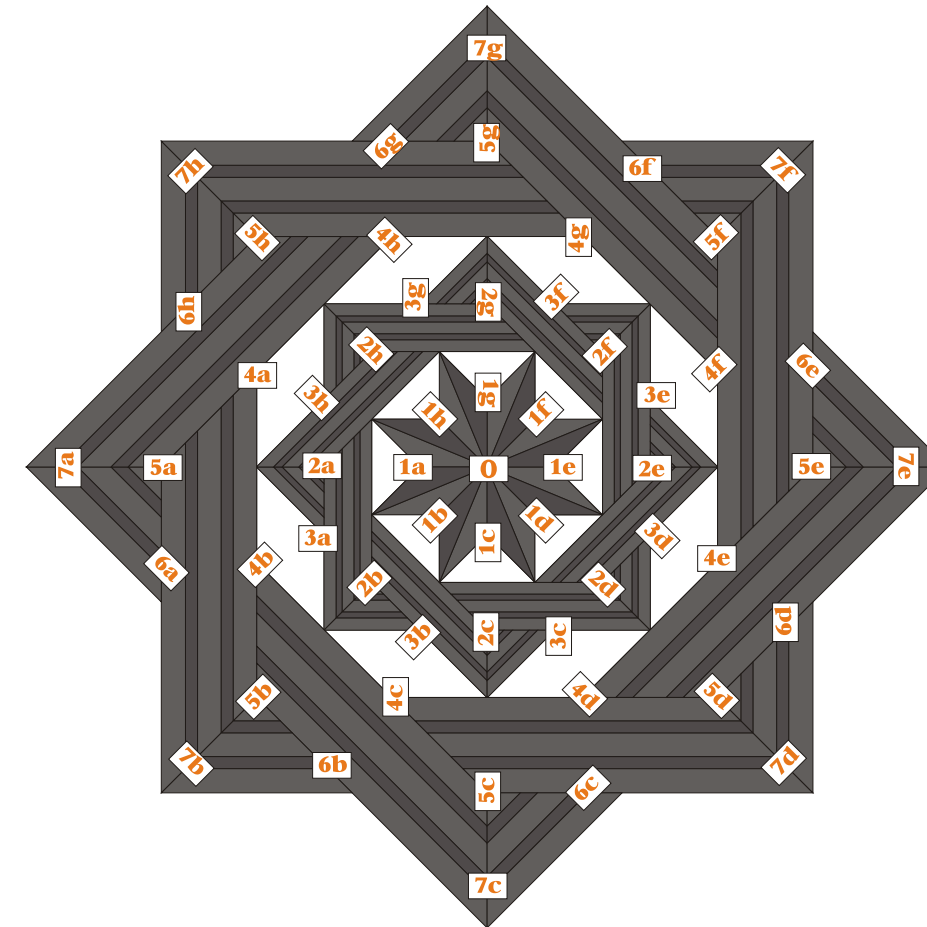

3. Final Tape Application

a layer of special cross-filament adhesive tape is applied to the face of the medallion - over the marks - this final layer will help keeping the medallion components together during transport and handling

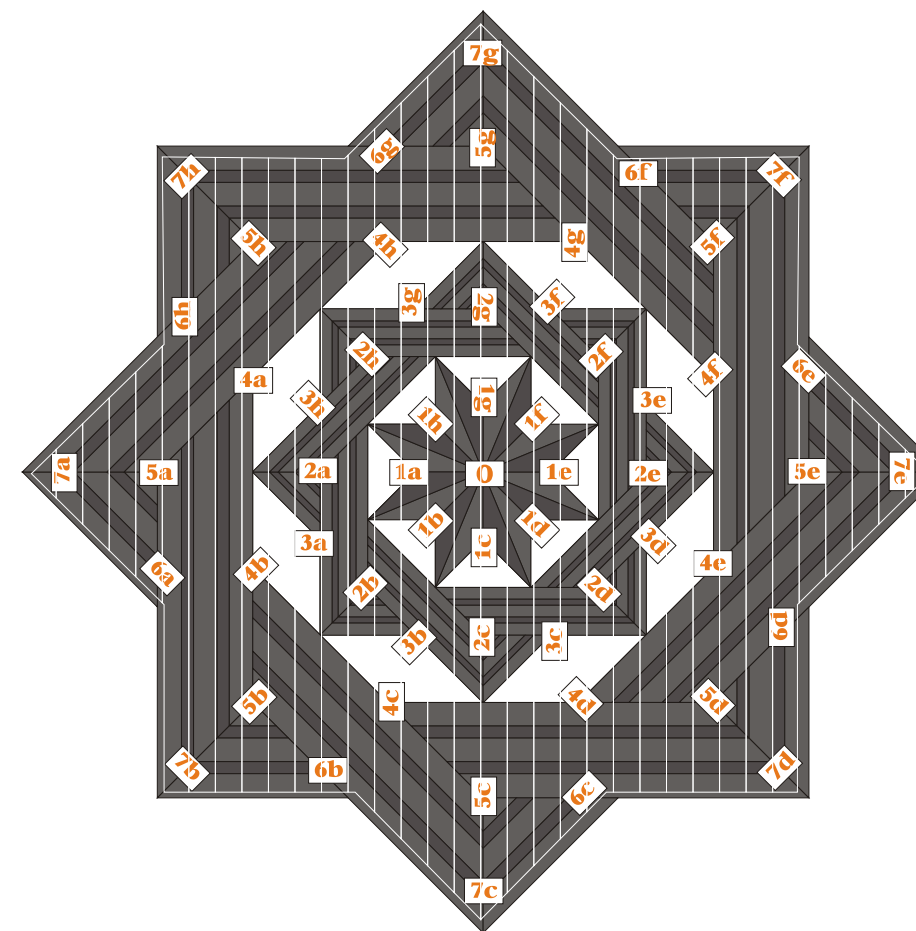

4. The Cutting

for transport efficiency reasons the medallion is cut into 20 components
- 4 pieces for the middle medallion &
- 16 pieces the exterior frame
that are packed in a cardboard box
during the transportation to the
customer premises

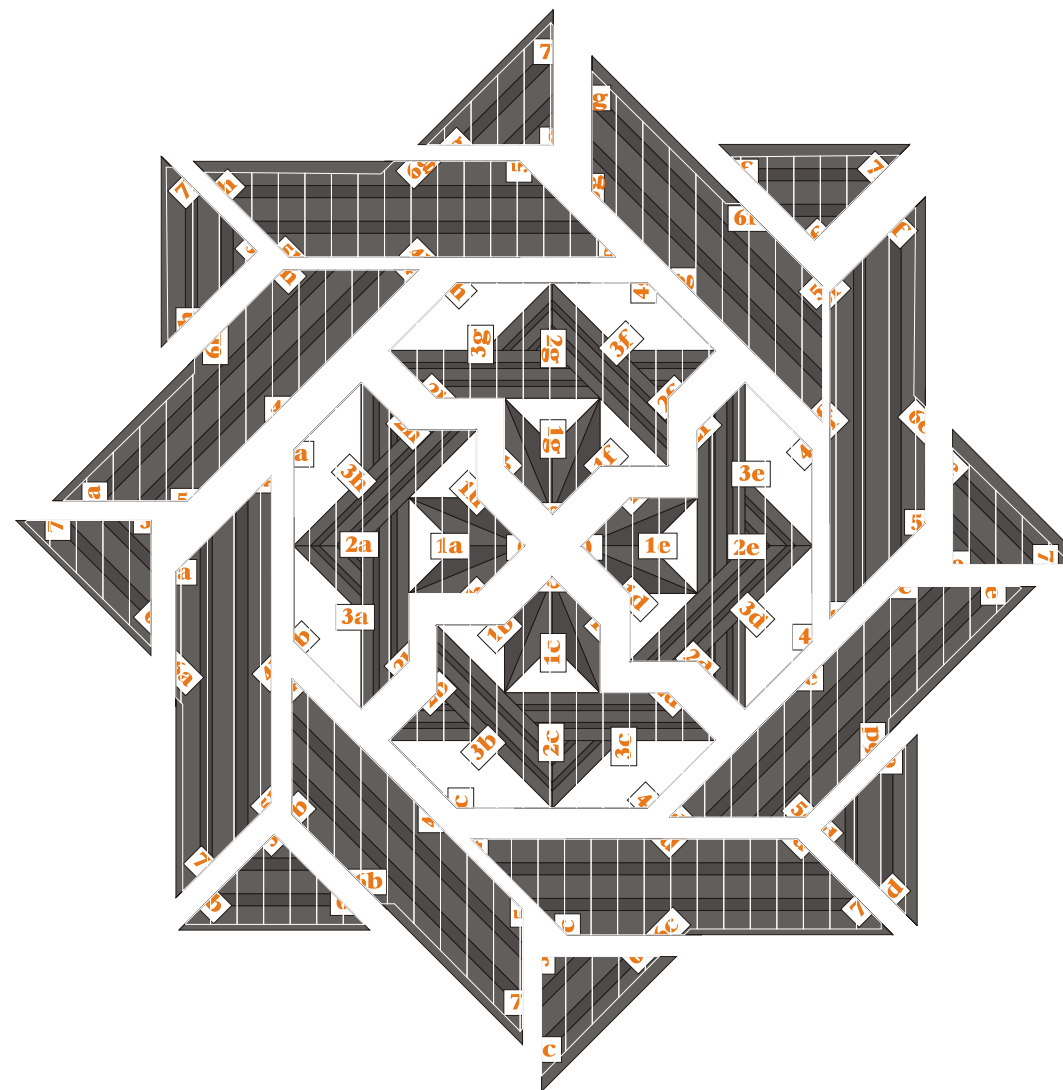

5. The Packing

the components are stacked in 2 separate packages, after combined in one package, wrapped in a polyethylene film and inserted in the delivery box

Center Medallion (4 pieces)

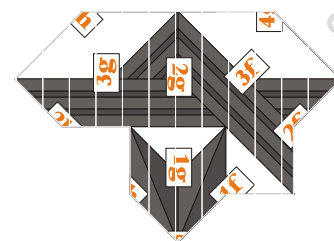

The Frame (16 pieces)

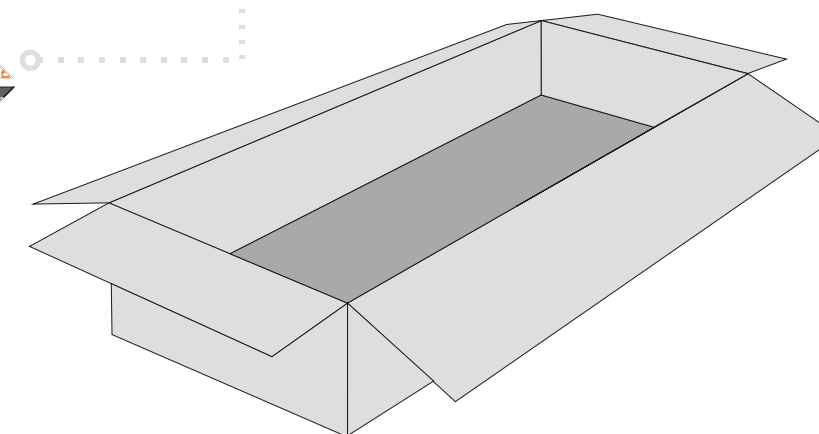
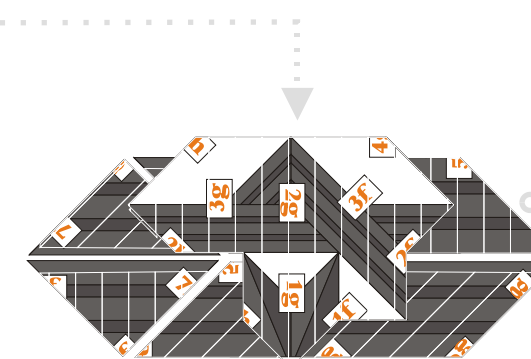
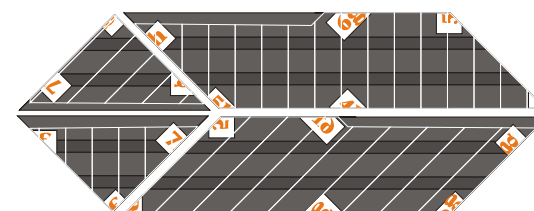

Cardboard Box

6. The Additional Support

for the case where the total thickness of the surrounding floor is higher than 10 mm (5/16 or 3/8 inch) we provide a support that adds thickness to the medallion;

this support is made of birch plywood

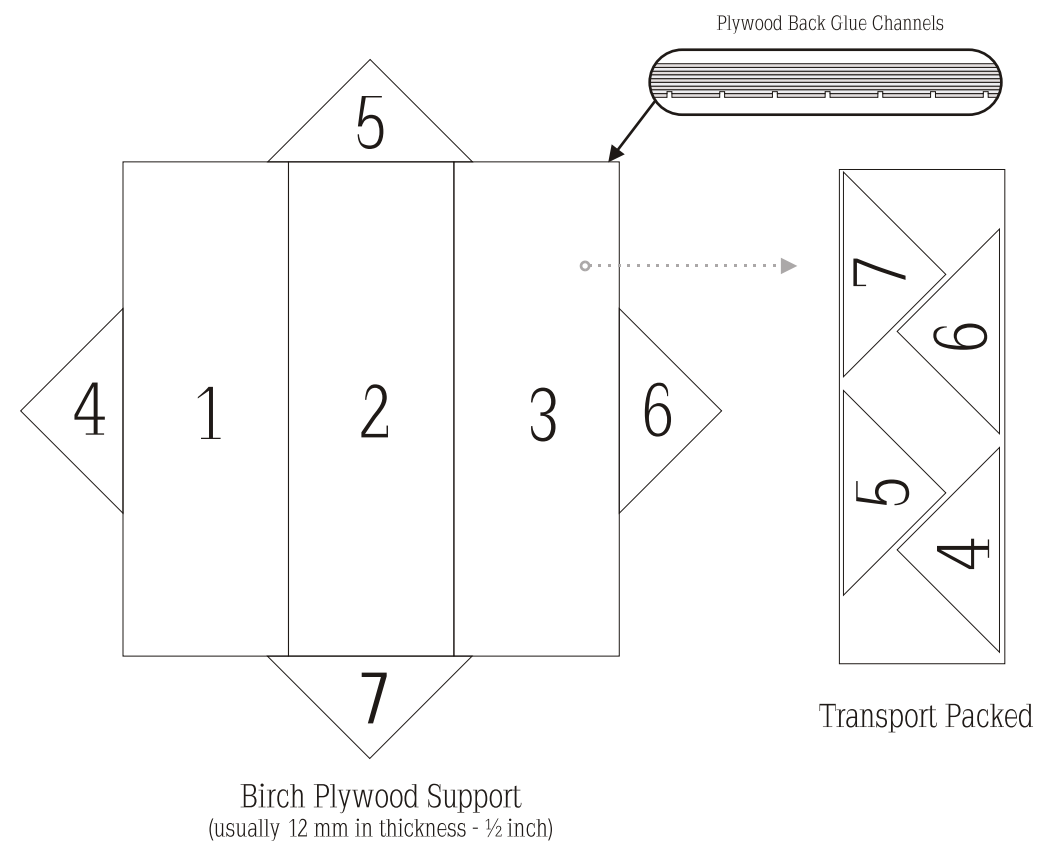



Version 1.01

Pavex Parquet SRL

11, Traian Street
Sebes, Alba County
515800 ROMANIA

T/F: + 40 - 258 - 730.786
M: + 40 - 771 - 322.893
or + 40 - 741 - 048.738
e-Mail: pavex.parquet@gmail.com

© Copyright Pavex Parquet srl. All rights reserved.

www.pavexparquet.com